

SERVOCONTROLS

Save Energy with Feedback

Hydraulic /Electric Motion Controllers

(Cadillac of Motion Control)



Motion Platforms



Steel Mills



Paper Pulp Refiner



Hydraulic Press Brakes



Roll Forming



Testing



Injection Molding



Fatigue Testing



Applications

- Steels Mills
- Paper Industry
- Power Generation
- Casting / Forging
- Metal forming / Welding
- Hydraulic Press brakes
- Motion Platforms & Entertainment
- Fatigue / Hydraulic / Structural Testing
- Aerospace / Automotive Testing
- Injection & Blow Molding
- Precision component manufacturing



RMC70

1-2 Axes Motion Controller



RMC150E

1-8 Axes Motion Controller

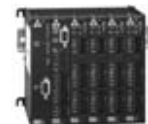

RMC100

1-8 Axes Motion Controller



VC2124 / VC2100 / VC2100-HS

Voltage to Current converters

sales@servocontrolsindia.com

www.servocontrolsindia.com

www.deltamotion.com

SERVOCONTROLS

Save Energy with Feedback

RMC70 Series 1-2 Axes

Motion Controller

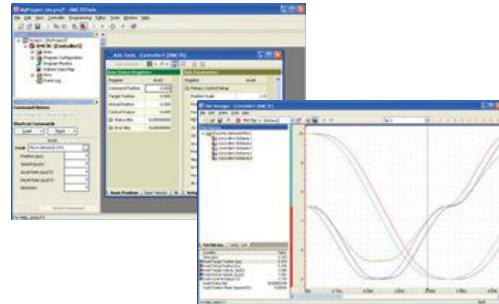

The RMC70 Series motion controllers offer a valuable combination of performance and ease-of-use for one and two-axis systems. Smooth, precise motion boosts throughput, improves quality, and extends machine life.

A number of feedback options are available, allowing one controller family to be used in a wide variety of hydraulic, electric, and pneumatic position and position– pressure/force applications.

The RMC70 motion controllers support multiple application types making use of acceleration and velocity feed forwards for controlling motors in velocity or torque mode, and separate directional gains for precise hydraulic control.

Efficient communication to popular PLCs and HMIs the RMC70 mirrors PLC addressing makes system integration quick and easy. For more performance, time-critical sequences can be offloaded from the PLC into the RMC70's

flexible User Programs. Command-based programming eliminates tedious coding, speeds development, and reduces long-term software maintenance. Advanced graphing and diagnostic capabilities can be used to troubleshoot the entire motion system. RMC70Tools software with informative help is downloadable from deltamotion.com.

Features

Setup and Programming

- ◆ Command-based minimal program development and maintenance
- ◆ Flexible User Programs advanced step sequencer with user named variables and mathematical expressions
- ◆ Extensive, context sensitive online help

Control Algorithms

- ◆ Position, velocity, pressure, force, position–pressure, position–force, velocity–pressure, velocity–force, active damping
- ◆ Full parameter set supports high performance motion control

Tuning and Diagnostics

- ◆ Powerful motion graphing and event logging for optimizing the entire motion system
- ◆ Event Log shows real-time activity

DELTA
COMPUTER SYSTEMS
Motion Control

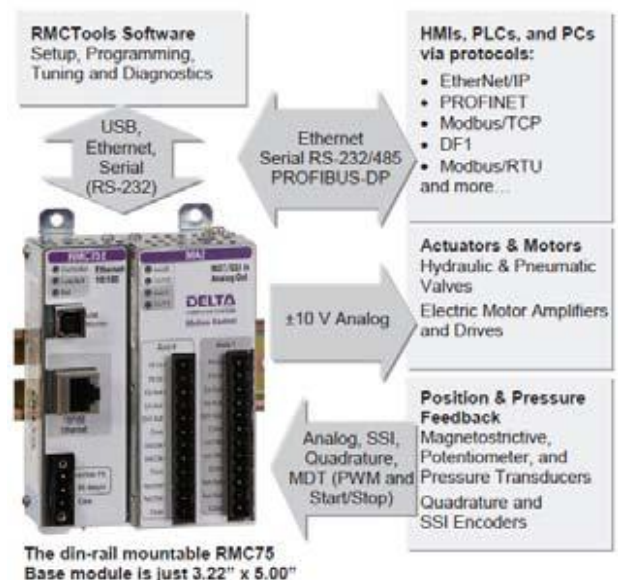
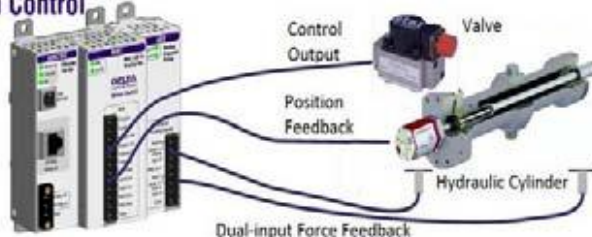



Communication Slot

Digital I/O
Profibus-DP
Universal I/O

CPU Slot

RMC150E- Motion Control CPU
RMC151E- RMC150E CPU with
Dual Loop Pressure /Force Control Option

Axis Module Slots

MDT
SSI
Quadrature
Resolver
Analog
Universal I/O
Digital I/O

The RMC150/151 delivers high-performance motion control to hydraulic, electric servo, and pneumatic industrial applications. With powerful control modes including dual-loop position-pressure algorithms and connectivity to many transducer types, the RMC provides optimum control for a wide range of motion applications.

As Delta's most advanced motion controller, the RMC150/151 CPU module comes standard with Ethernet, supporting protocols such as EtherNet/IP, PROFINET, and Modbus/TCP, and is designed to integrate easily with your favorite PLCs, PCs and HMIs.

Equipped with excellent graphing features and easy-to-use wizards, the RMCTools software handles setup, programming, tuning and diagnostics for both the RMC150 and RMC70 series controllers.

Flexible Multi-axis Capability

Modules can be "mixed and matched" to support up to 8 control axes for tightly synchronized motion, and additional reference axes up to a total of 16 control, reference or virtual axes.

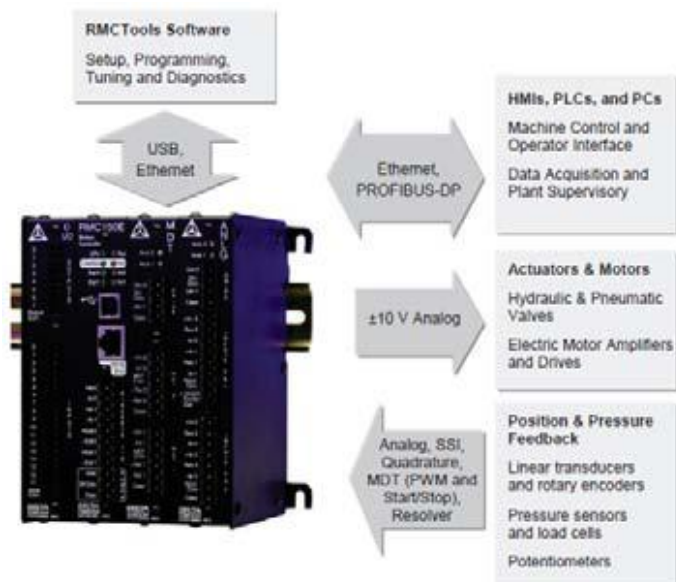

Communications

- ◆ Ethernet (10/100 Mbps), built-in on CPU.

EtherNet/IP, PROFINET, Modbus/TCP, CSP (Allen-Bradley), FINS (Omron), Procedure Exist (Mitsubishi Q-series)

- ◆ USB Port

For use with the RMCTools software.

- ◆ PROFIBUS-DP

Feedback Types

- ◆ **Magnetostrictive Linear Displacement Transducer (MDT)**

RS-422 Start/Stop and PWM signals

- ◆ **Synchronous Serial Interface (SSI)**

Linear and single- or multi-turn rotary

- ◆ **Analog**

±10 V and 4-20 mA

- ◆ **Quadrature Encoder**

5 V differential only (RS-422)

- ◆ **Resolver**

Wide range of frequencies and ratios

Control Modes

Closed Loop Control

Full PID loop control with velocity, acceleration and jerk feed forwards for precise synchronized motion.

Position Control

- ◆ Point-to-Point moves
- ◆ S-curves
- ◆ Speed at Position
- ◆ Gearing
- ◆ Cyclic Sinusoidal Motion
- ◆ Splines, Cams
- ◆ Rotary motion (incremental and absolute)

Velocity Control

- ◆ Velocity control with position feedback
- ◆ Velocity control with velocity feedback

Pressure and Force Control

- ◆ Pressure sensor, load cell or differential force
- ◆ Linear or S-curve Ramps
- ◆ Gearing
- ◆ Cyclic Sinusoidal Profile
- ◆ Splines, Cams

Position-Pressure and Position-Force Control

- ◆ Transition seamlessly between position control and pressure or force control.
- ◆ Pressure or Force Limit – limit the pressure or force during a position or velocity move.

Active Damping

- ◆ For high-performance control of pneumatics and difficult systems.

Open Loop Control

- ◆ Seamless transition from open loop to closed loop. Ramp Control Output between two values, or ramp based on position for hard-to-control systems.

Quick Move

- ◆ Move in open loop and stop in closed loop for fast,
- ◆ smooth motion with accurate stops.

High level programming

◆ User Programs

Programs are easy-to-understand sequences of commands. Run multiple programs simultaneously to handle axis commands and machine control functions.

◆ Program Triggers

Start user programs automatically based on user defined events such as discrete inputs, error conditions, etc.

◆ Variables

Recipes and other user parameters can be store for use by user programs.

◆ Mathematical Expressions

Expressions provide flexible programming capability for advanced calculations and machine control sequences.

Trouble shooting and monitoring

◆ Plots

Plot any register in the RMC70, up to 16 registers per plot, sampled down to the control loop resolution.

◆ Event Log

Speeds troubleshooting by recording events such as parameter changes, commands, errors

Fault Handling

◆ Closed Loop stops

Ramp speed to zero at specified rate and hold position.

◆ Open Loop stops

Ramp output voltage to zero at specified rate.

◆ Multi-axis (group) stops

A fault on one axis halts multiple axes when configured as a group.

◆ Auto Stops

The response of axes to each fault type is easily configurable.

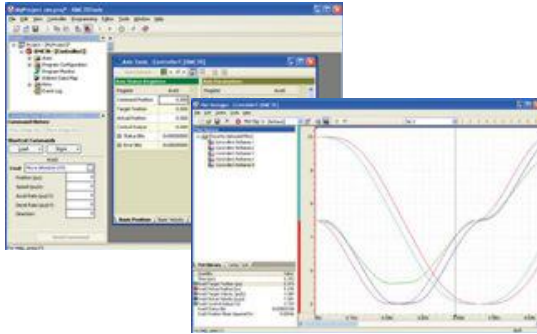

RMCTools Software

RMCTools is a powerful motion control software package for setting up, tuning, troubleshooting, programming, and controlling all features of Delta's multi-axis RMC70 & RMC150/151 controllers from a PC.

Delta's intuitive and easy-to-use RMCTools software features flexible User Programs with extensive commands and the ability to embed mathematical expressions. Setup and tuning wizards reduce startup times, and the graphical diagnostics tools speed troubleshooting of the entire motion system. Extensive, context sensitive help is included in RMCTools, giving you the information you need at your finger tips.

Communication Software

RMCLink ActiveX Control and .NET Assembly

RMCLink enables full monitoring and control of RMC70 & RMC150/151 motion controllers via Ethernet communications from custom applications on Windows®-based PCs. RMCLink supports numerous languages, such as Visual Basic, C++, C#, VBScript, VBA (Microsoft Excel®), LabVIEW.

RMCLink comes with fully-functioning sample projects to help you get up and running quickly. The help includes detailed walkthroughs and numerous code snippets.

Instrument Driver for Use with LabVIEW

VIs created by Delta for use with LabVIEW software provide full fledged examples including plot uploading and trending. The VIs are available from the Instrument Driver portion of National Instruments' website and from www.deltamotion.com.

RMCTools Features

Delta's powerful RMCTools software makes setup, tuning, and troubleshooting motion systems easier than ever.

Setup

◆ Wizards

Easy-to-use wizards include New Project, New Controller, Scale & Offset, and Auto tuning.

◆ Full Parameter Set

Monitor all axis status registers and modify parameters. Tuning and Diagnostics

◆ Plots

Plot any register in the RMC, up to 16 registers per plot, sampled as fine as the control loop resolution.

◆ Auto tuning Wizard

Quickly and accurately tune your axes, using a slider bar to choose from a range of gains appropriate for your system.

◆ Event Log

Speed troubleshooting by recording events such as parameter changes, commands, errors, and communications.

◆ Program Monitor

Monitor User Program execution and variables.

Programming

◆ Commands

Issue commands directly from RMCTools. Use Shortcut Command Sets to quickly issue commands to speed the tuning process.

◆ User Programs

Easily create programs to issue sequences of commands.

◆ Program Triggers

Start user programs automatically based on user-defined events such as discrete inputs, error conditions, etc.

◆ Mathematical Expressions

Expressions provide flexible programming capability for advanced calculations and machine control sequences.



The RMC100 series brings the benefits of modular, high performance motion control to a wide range of industrial applications. Communication options ranging from high speed fieldbuses to discrete I/O make these controllers an excellent choice for large and small systems. Transducer types can be combined to control any hydraulic, electric, and pneumatic system. Powerful control modes including position/pressure control, synchronized moves, gearing, splines, and teach mode provide optimum control for your motion applications.

Applications

- ◆ Presses
- ◆ Injection/RIM/blow molding
- ◆ Packaging equipment
- ◆ Indexing/transfer lines
- ◆ Edger's / head rigs / veneer lathes
- ◆ Pinch rollers/winders/wrappers
- ◆ Casting/forging
- ◆ Palletizers/stackers
- ◆ Flying cutoff/curve sawing
- ◆ Cyclic testing
- ◆ Robotics/animatronics
- ◆ Pneumatic press rolls
- ◆ Tube bending/forming

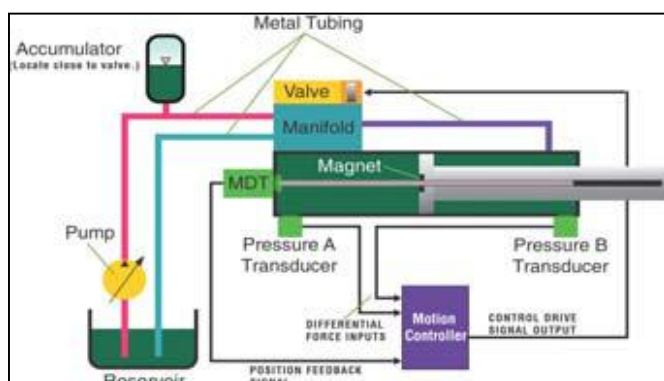

Features

- ◆ Two to eight axes of position or speed control
- ◆ Isolated power input, drive outputs, discrete and analog I/O, and communications
- ◆ RS-232 port for RMCWin and the RMCCOM ActiveX Control
- ◆ Full PID with velocity and acceleration feed-forwards
- ◆ Motion and pressure profiles can be changed on-the-fly
- ◆ 256K bytes FLASH memory for field upgrades and parameter storage
- ◆ Trapezoidal, S-curve, and spline profiling
- ◆ Teach mode
- ◆ Synchronization of 2-8 axes
- ◆ Electronic gearing
- ◆ Compact DIN-rail mount package

Communications

- ◆ PROFIBUS-DP
- ◆ Ethernet
- ◆ Modbus Plus
- ◆ Discrete I/O – 20 inputs, 10 outputs
- ◆ Serial (RS-232/422/485)

Feedback Types

- ◆ Magnetostrictive Transducers – Start/Stop, PWM, and SSI
- ◆ Analog Transducers – 16 bit
- ◆ Quadrature Encoders
- ◆ Absolute encoders and resolvers with Synchronous Serial Interface

Drive Outputs

- ◆ All feedback interfaces are available with analog ± 10 Volt outputs
- ◆ Quadrature and SSI feedback interfaces are available with stepper output

SERVOCONTROLS

Save Energy with Feedback

RMCWin Programming

Software for RMC100/101 Controllers

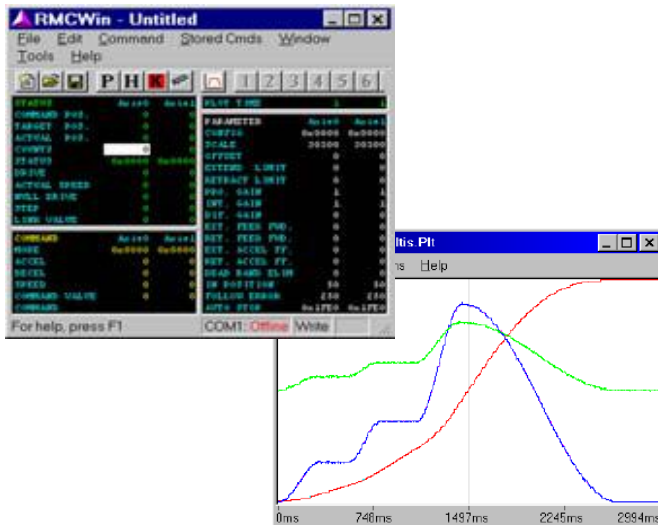

RMCCOM ActiveX Control

Control the RMC from your Visual Basic, Visual C++, Java, and VBA (e.g. Excel) programs.

Pressure / Force Control option

- ◆ Control pressure or differential force at 12- or 16-bit resolution
- ◆ Transition between position and pressure/force while in motion

RMCWin Software

Delta's powerful RMCWin for Windows 95/98/NT/2000/XP makes setup, tuning, and troubleshooting motion systems easier than ever.

- ◆ Provides a graphic display of the latest motion profile, position and drive information
- ◆ Includes context-sensitive help and complete user manual online
- ◆ Calculates scale, offset, and velocity feed forwards
- ◆ Allows user to activate motion profiles and change control parameters from a PC
- ◆ Displays parameter and status information for all axes

Event Control

- ◆ Repeatable execution of motion commands each loop (1 or 2ms)
- ◆ Provides easy, spreadsheet-style programming
- ◆ Responds to time delays, status bit conditions, position, or inputs
- ◆ Includes 256 event steps



Event Steps Editor

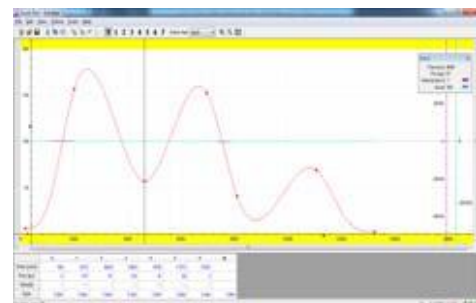

Curve Tool Edition

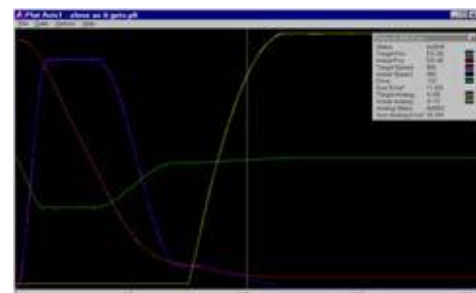

Plots

VC2124



The VC2124 voltage-to-current converter transforms $\pm 10V$ signals into current signals capable of driving hydraulic servo valves or similar loads. It also provides a convenient way to set the full scale current to match valve requirements, limit maximum current, or set optimum working ranges.

Features

- ◆ Two channels of voltage-to-current conversion
- ◆ Full scale output current switch-selectable from $\pm 10mA$ to $\pm 100mA$ in 10mA steps (each channel set independently)
- ◆ Inputs and outputs can be paralleled for output current up to $\pm 200mA$
- ◆ Dual-color LEDs indicate input polarity and amplitude
- ◆ LEDs indicate output saturation (typically caused by loss of connection to the valve or excessively high load resistance)
- ◆ Outputs protected against inductive voltage spikes and short circuits
- ◆ Compact DIN-rail mount package
- ◆ Powered by single 24V supply
- ◆ 24V power supply isolated from inputs and outputs

Wiring

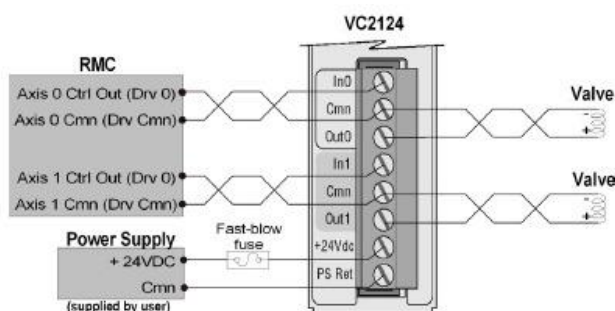

VC2100 / VC2100-HS



The VC2100 voltage-to-current converter transforms $\pm 10V$ signals into current signals capable of driving hydraulic servo valves or similar loads. It also provides a convenient way to set the full scale current to match valve requirements, limit maximum current, or set optimum working ranges.

The VC2100-HS is a high-speed version of the VC2100, providing a response time of 15 kHz, compared to 1.4 kHz for the VC2100. In all other respects, these two versions share the same specifications.

Features

- ◆ Two channels of voltage-to-current conversion
- ◆ Full scale output current switch selectable from $\pm 10mA$ to $\pm 100mA$ in 10mA steps (each channel set independently)
- ◆ Inputs and outputs can be paralleled for output current up to $\pm 200mA$
- ◆ Dual-color LEDs indicate input polarity and amplitude
- ◆ Outputs protected against inductive voltage spikes and short circuits
- ◆ Compact DIN-rail mount package
- ◆ Use with $\pm 12V$ to $\pm 15V$ power supplies

Wiring

